

# Play & Leisure Ltd

## Installation Details For Venture Quest Multi Unit (Q109)

<u>Component List</u>	<u>Quantity</u>
2.6m Post	6
Glider Bars – Curved	1
Snake Climber	1
Spiders Web	1
Triangular Platform	1
1.4m Slide Set	1
Access Board	1
Hang Tough	1
Walkerboard	1
Rotating Platform	1
Pull Up Bar – Straight	1
Walkerboard – Semi	2
Grab Handle	1

- 1 Construct base as per layout drawing 1 ensuring the correct levels for safety surfacing.
- 2 Excavate 400mm x 400mm holes for Posts as in drawing 2 to a depth of 500mm (**800mm for loose fill**) from finished safety surfacing height. (All Posts have finished ground level marks)
- 3 Position the Posts as per drawing 2
- 4 Fit the Posts in to the excavated holes and connect together using the various components as in drawing 3 and the attached visual
- 5 Excavate 400mm x 400mm holes for events as in drawing 3 to a depth of 500mm (**800mm for loose fill**) from finished safety surfacing height
- 6 Connect the events as per drawing 3 using M10 x 30 resistorx & nylon washers
- 7 When installing the slide chute attach the ground leg using the 2no M10 x 25 resistorx & nylon washers
- 8 When installing the rotating platform assemble the top wishbone, remove the cap from the rotator top and insert into the wishbone making sure it is inserted all the way in. before concreting in place make sure the rotator is spinning freely
- 9 When installing the Hang tough use drawing no. I/QUHT/01
- 10 Assemble all other items of equipment as drawing 3 using M10 x 30 resistorx bolts & plastic caps
- 11 Connect all ropes using the 8mm quick links & vandal pins
- 12 Once all equipment is fitted check levels again, tighten all bolts and concrete into the ground

**Note: Do not leave unattended until satisfied the concrete has cured or the site is secure**

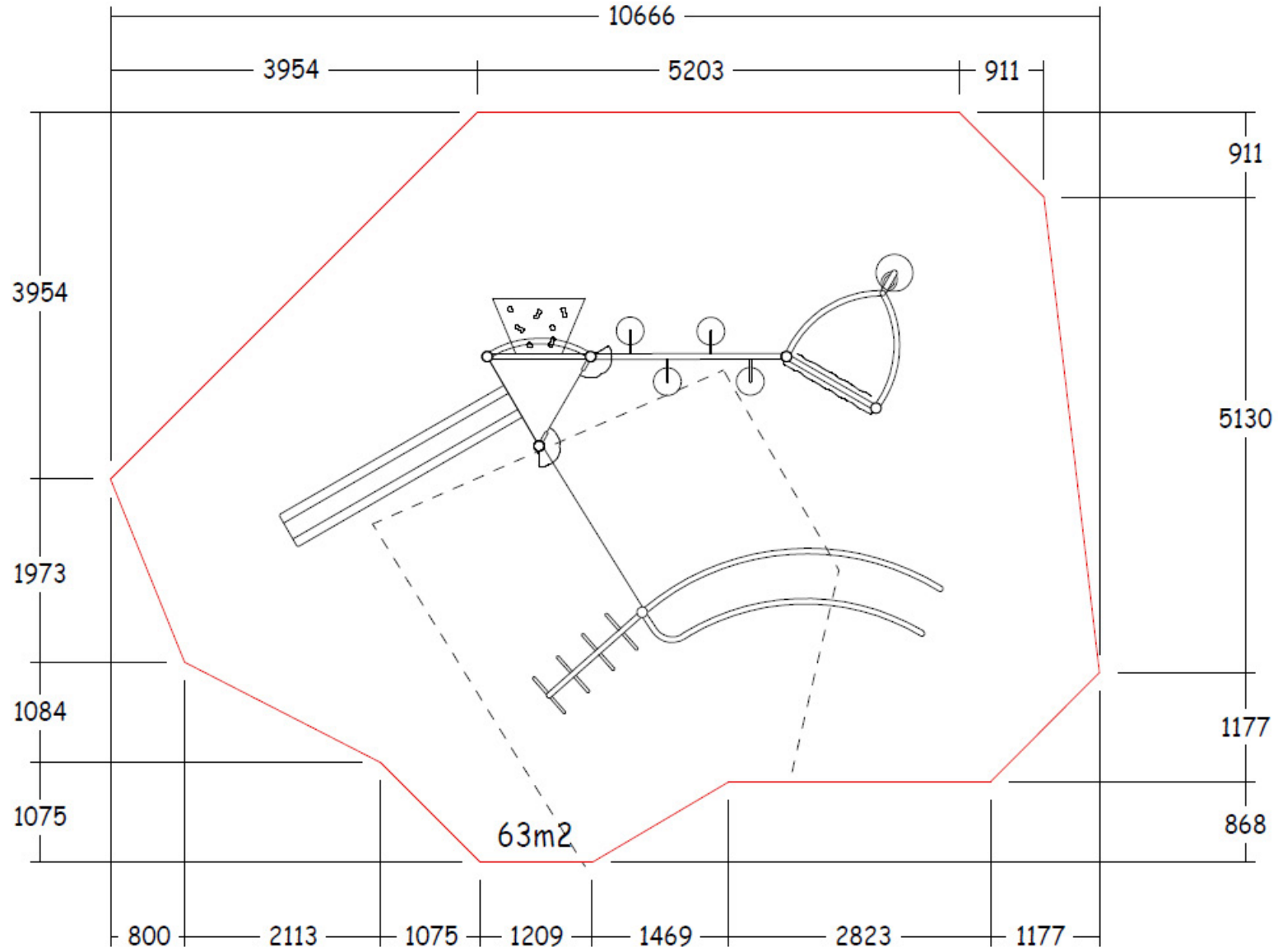

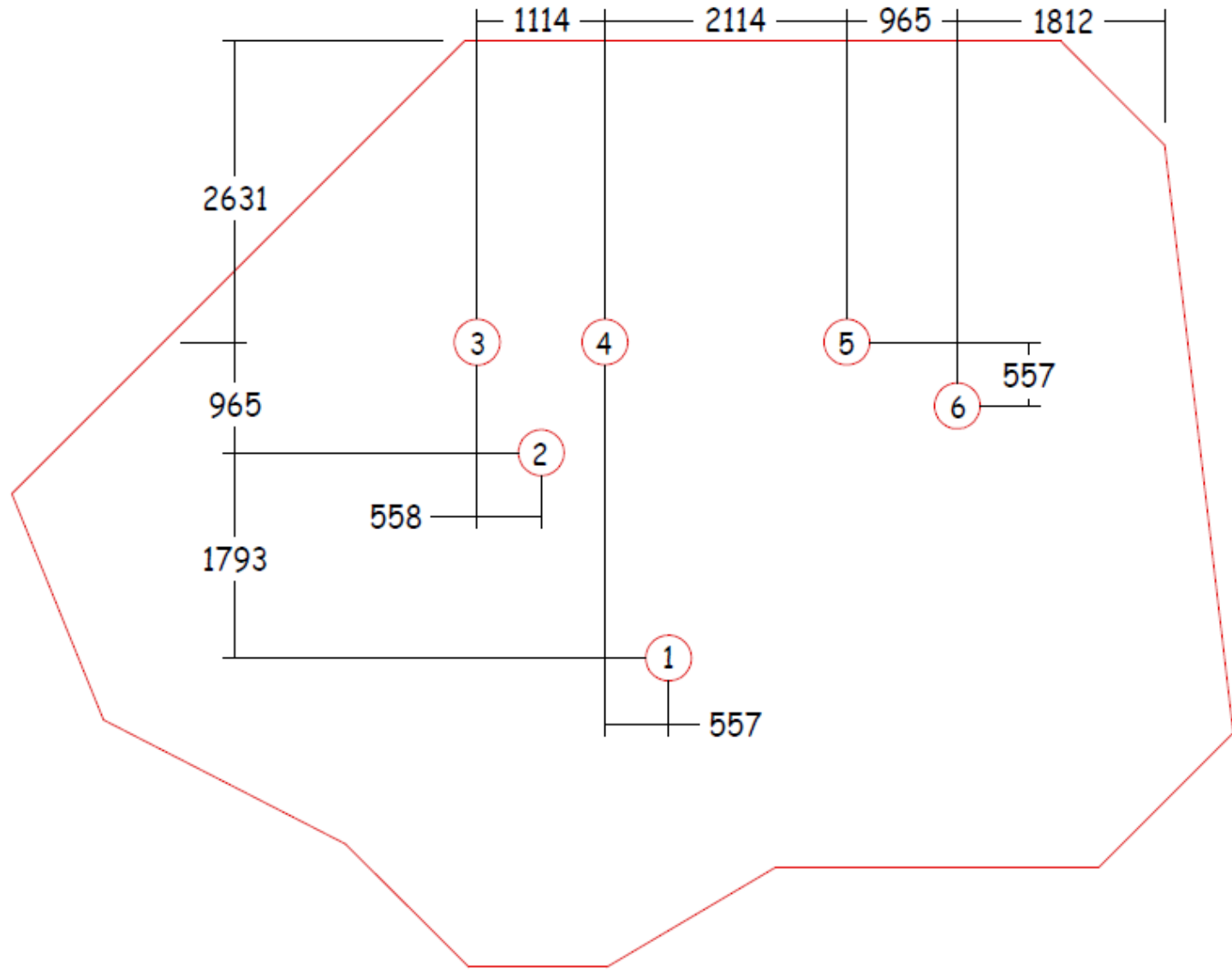

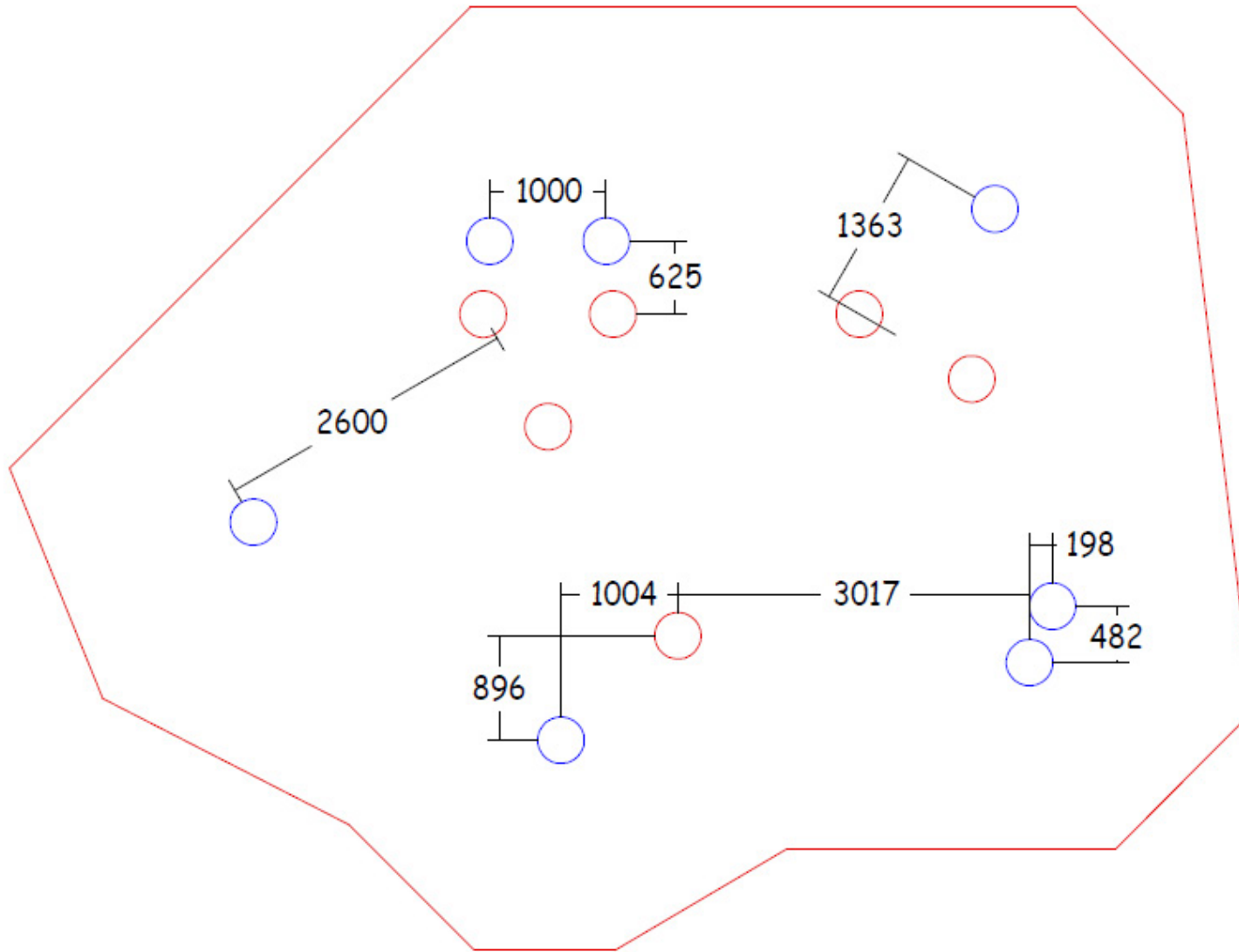

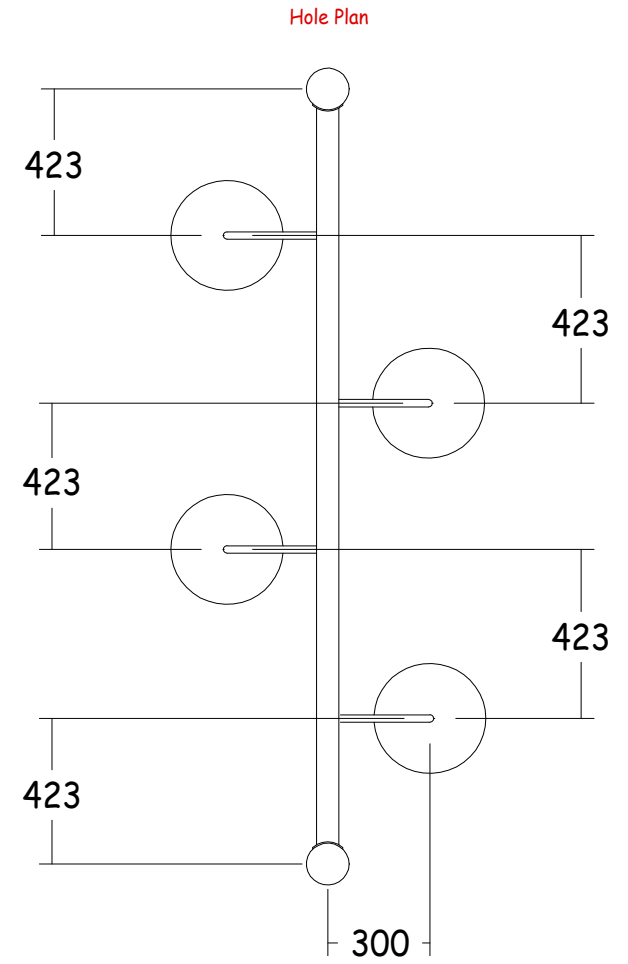
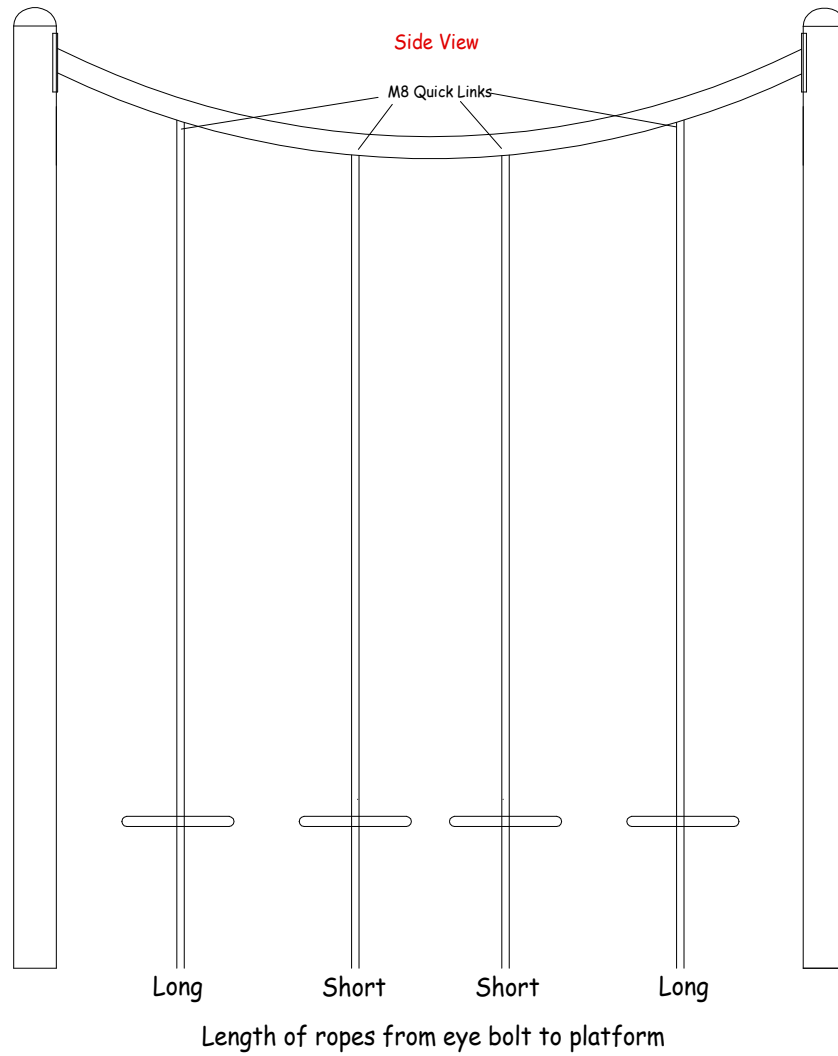

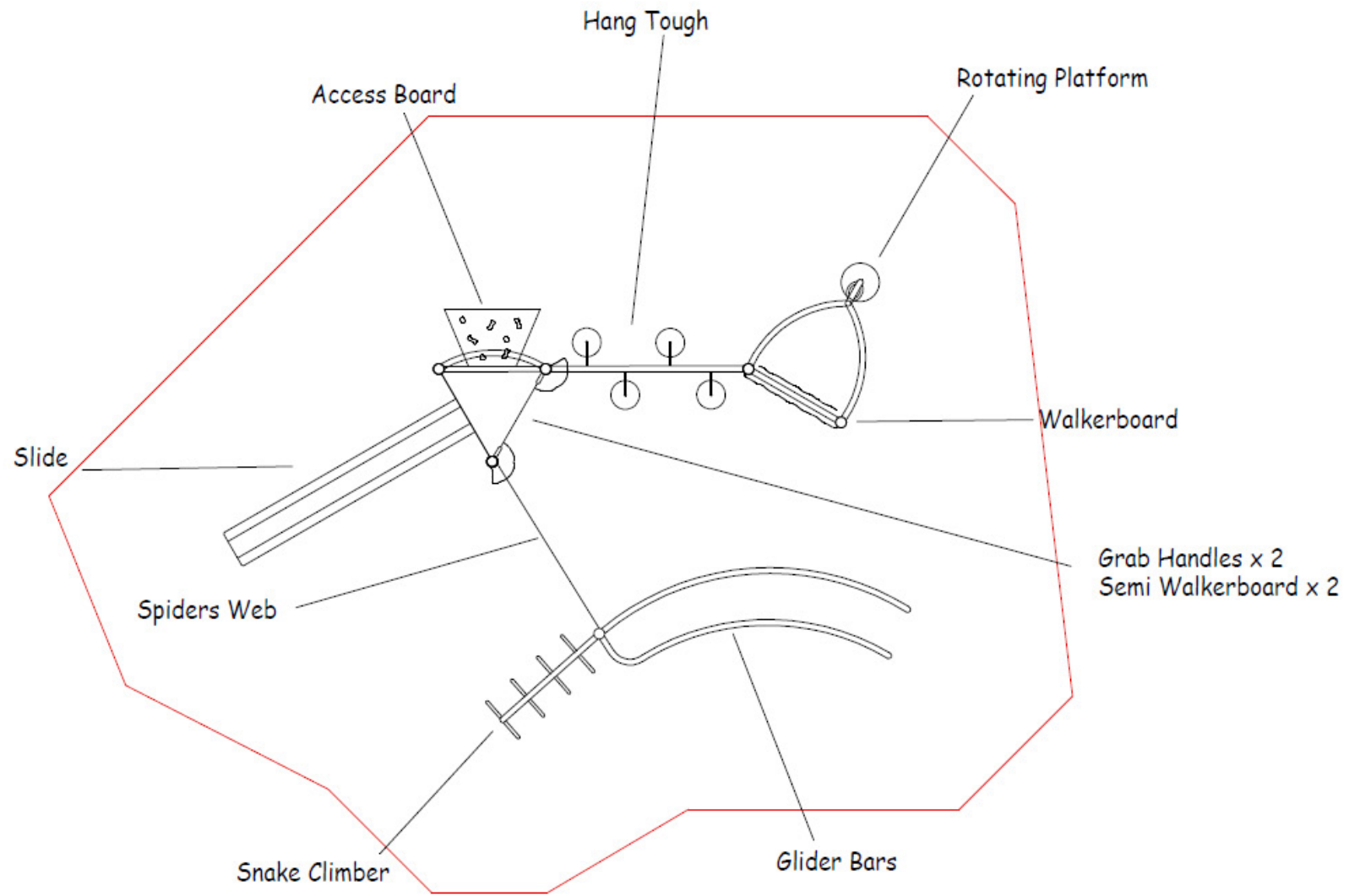

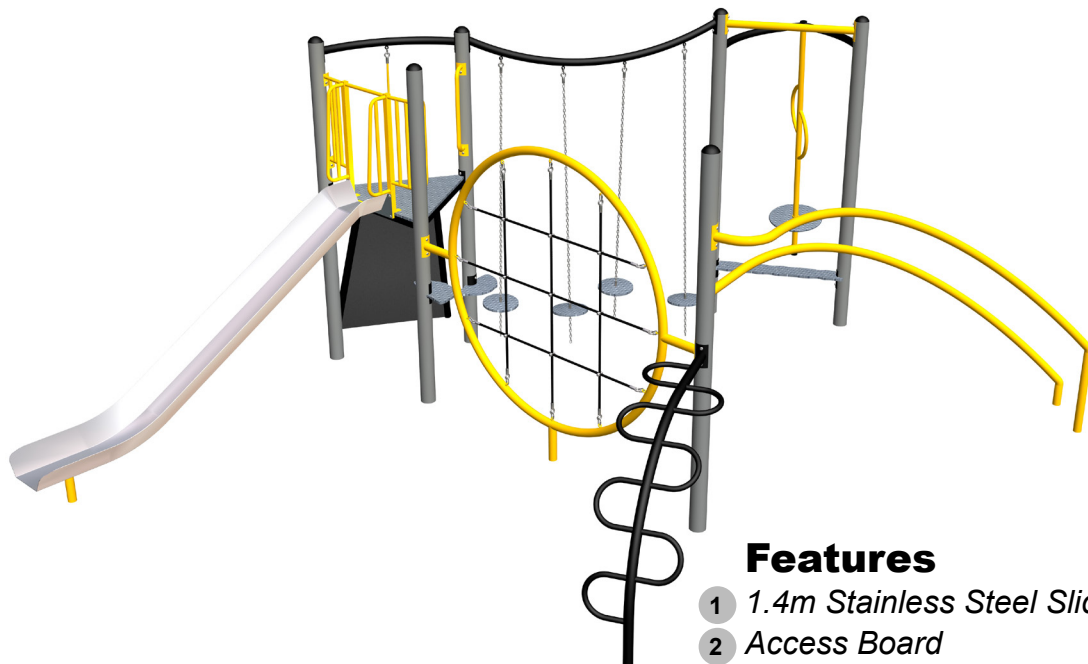

**Features**

- 1 1.4m Stainless Steel Slide
- 2 Access Board
- 3 Hang Tough
- 4 Rotating Platform
- 5 Pull Up Bar Straight
- 6 Walkerboard
- 7 Triangular Platform
- 8 Grab Handles
- 9 Walkerboard - Semi
- 10 Spiders Web
- 11 Snake Climber
- 12 Glider Bars - Curved

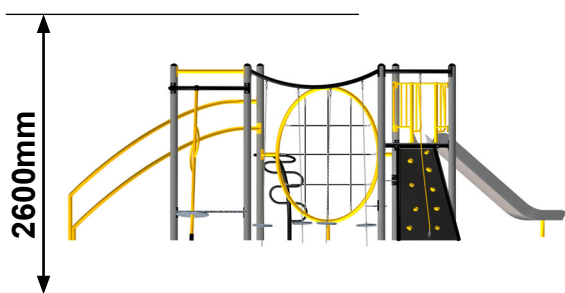

All Play & Leisure's product range is fully compliant with **BS EN 1176**

Side Elevation

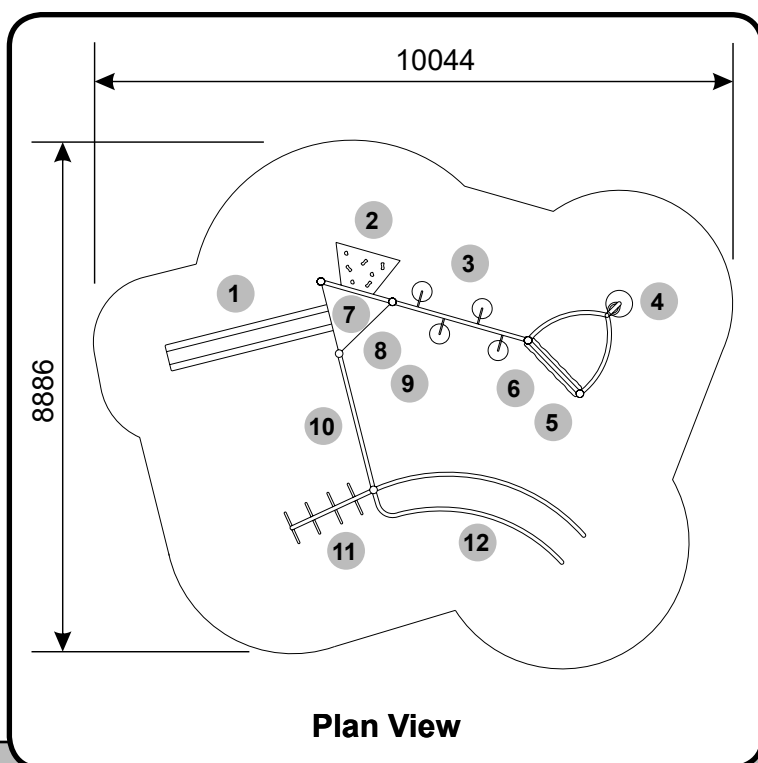

Plan View

**Technical Information**

<b>Product Code</b>	Q109
<b>Equipment Size (mm)</b>	7382Lx 5338W x 2600H
<b>Minimum Space (mm)</b>	10044 x 8886
<b>Free Height of Fall (mm)</b>	2500
<b>Safety Surface Area</b>	63m <sup>2</sup>
<b>User Age Range</b>	7-14 Years

# Play & Leisure Ltd

## Maintenance Schedule

### **Maintenance & Inspection**

All Play & Leisure's products should be inspected and maintained in accordance with the recommendations as detailed in BS EN 1176-7:2008

If any part of the equipment is found to be unsafe during an inspection and cannot be immediately rectified the equipment should be protected against further use.

### **Routine Visual Inspection.**

Routine visual inspections are to be conducted to identify obvious hazards resulting from vandalism, use or weather conditions. e.g. Hazards such as broken parts or broken bottles.

### **Operational Inspection.**

To reduce accidents the operator should ensure an appropriate routine maintenance schedule is established, implemented and maintained. Inspection shall be carried out on a monthly basis, although consideration should be taken regarding local conditions and usage.

During a operational inspection the following should be included:

- Tightening of fastenings.
- Re-painting and re-treatment of surfaces.
- Maintenance of any impact attenuating surfaces.
- Lubrication of bearings.
- Marking of equipment to signify loose fill finished surface levels.
- Cleaning.
- Removal of broken glass and other debris or contaminants.
- Restoring loose fills to the correct level.
- Maintenance of free space areas.

### **Annual Main Inspection (NOT EXCEEDING 12 MONTHS)**

Inspection intended to establish the overall level of safety of equipment, foundation and playing surfaces.

- Effects of weather.
- Rotting or corrosion.
- A change in the level of safety of the equipment as a result of repairs made, or of added or replaced components

### **One Post Equipment Maintenance.**

Special attention should be paid to the stability of products being of a one post design.

### **Corrective Maintenance.**

Corrective maintenance should include measures to correct defects, or to establish the necessary levels of safety of the playground equipment and surfaces. Such measures should include:

- Replacement of fastenings.
- Welding or welding repairs.
- Replacement of worn or defective parts.
- Replacement of defective structural components.

### **Equipment Alterations.**

Alterations to parts of any products that could affect the essential safety of the equipment should only be carried out after consultation with Play and Leisure.

### **Equipment Identification**

Information regarding the manufacturer, I.D. Number, year of manufacturer and the European Standard is displayed on an identification plaque.